

City of Schenectady Department of Engineering

Room 205, City Hall, 105 Jay Street
Schenectady, New York 12305-1938
Office (518) 382-5082 Fax (518) 382-1050

Office Use Only				
Application No.:	_____			
Permit No.:	_____			
Date Issued:	_____			
Liability Insurance	Attached:	<input type="checkbox"/>	On File:	<input type="checkbox"/>

SIDEWALK PERMIT

Instruction:

This application shall be completed in full, either typed or printed **clearly** in ink, and filed with the City of Schenectady Department of Engineering, at the above address above.

Description:

This application shall be used when a property owner or their representative is replacing or blocking the sidewalk. All required information for the replacing or blocking of the sidewalk can be found herein and/or within the City of Schenectady's Municipal Code Section [§228-18 - Duty of owner to maintain sidewalk; construction, repair or replacement](#). This Permit shall be allowed for a maximum of 30 days and require a fee of **\$50.00** to be paid in Room 100, City Hall 105 Jay Street, Schenectady, NY 12305.

Any work or obstructions within the City Right-of-way shall require submission of current liability insurance naming the City as additionally insured.

Before any excavation always call Dig Safely New - Call **811**

If work is to be performed by the Owner of the property please fill out the CE-200 form for an exemption of Workers' Compensation. This form can be found at:

http://www.wcb.ny.gov/content/ebiz/wc_db_exemptions/verifyCE200Overview.jsp

Part I: General Information

1. Work Site Address: _____
2. Start Date and Time: _____
3. Total Days Required: _____
4. Applicant's Information
 - a. Applicant's Name: _____
 - b. Street Address: _____
 - c. City, State, ZIP: _____
 - d. Telephone No.: _____
5. Contractor's name
 - a. Contractor's Name: _____
 - b. Street Address: _____
 - c. City, State, ZIP: _____
 - d. Telephone No.: _____
 - e. Emergency Name 24/7: _____
 - f. Emergency Phone #: _____

PART II PERMIT APPLICATION SKETCH
SAMPLE

Applicant: _____

Work Site Address: _____

Is there alternate side parking on street: Yes No

Notes/Comments: _____

LOCATION OF WORK

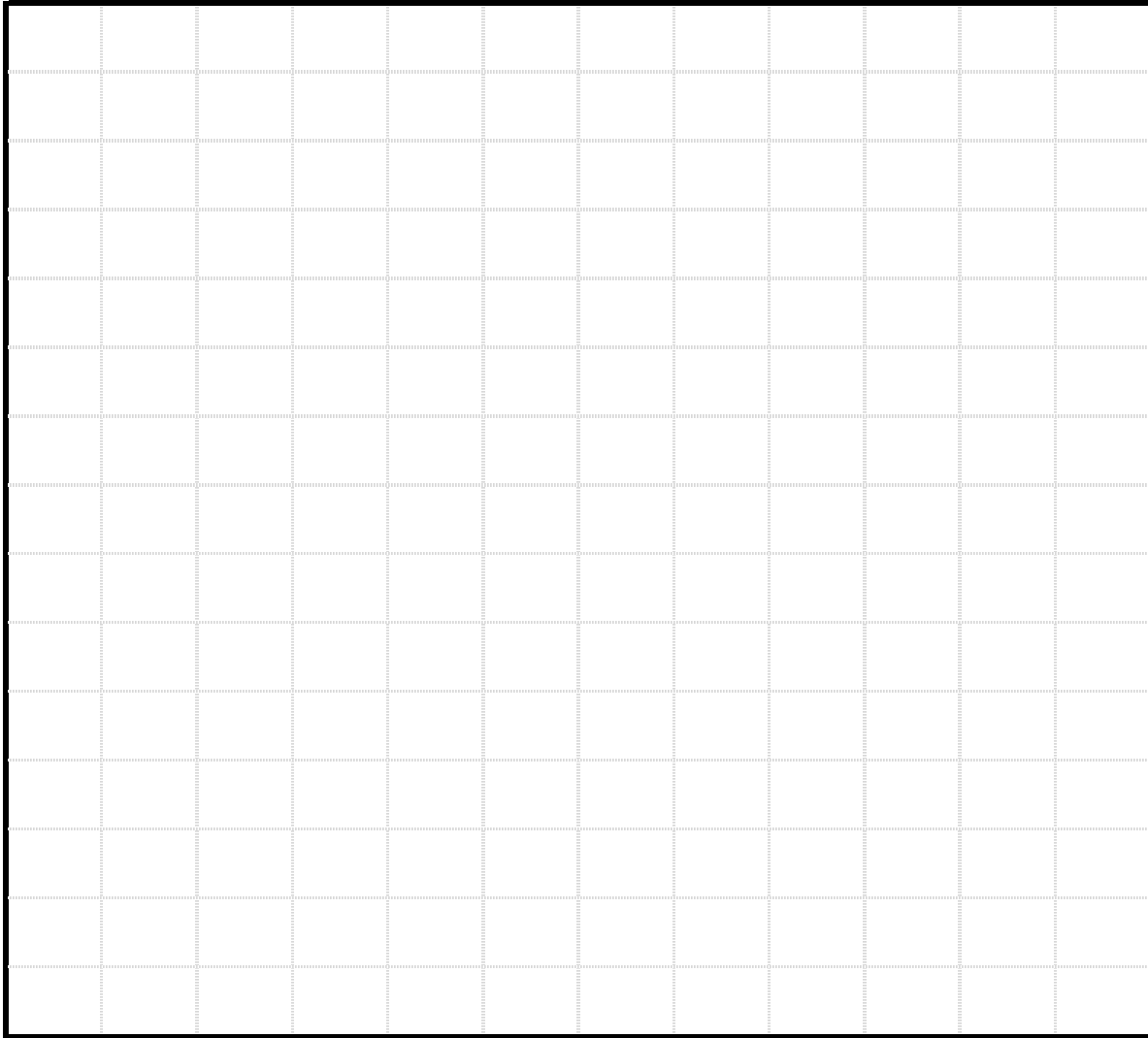

INFORMATION

- Show street name and house number.
- Show distance from curb face to building and from curb face to street side edge of proposed sidewalk.
- Show nearest Utility Pole and identify it by the affixed number.
- Draw a rough sketch of the proposed location and indicate sidewalk and driveway width and location where applicable.

PART II PERMIT APPLICATION SKETCH
SAMPLE

Applicant: JOHN SMITH

Work Site Address: 123 STATE STREET

Is there alternate side parking on street: Yes No

Notes/Comments: Replace 50 feet of sidewalk in front of 123 State St per City Specifications
Closest Utility pole NG-45 in front of 125 State Street.

LOCATION OF WORK

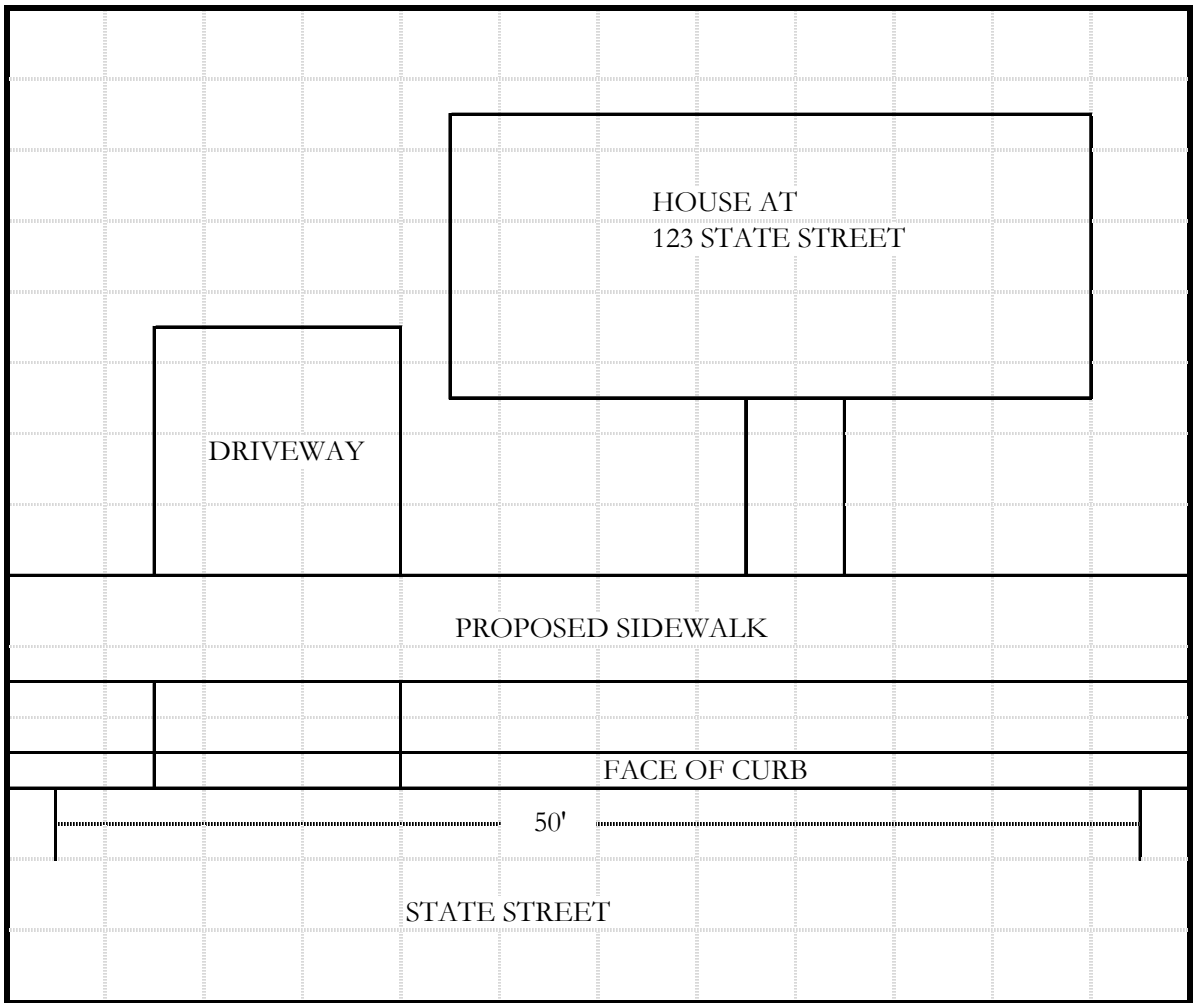

INFORMATION

- Show street name and house number.
- Show distance from curb face to building and from curb face to street side edge of proposed sidewalk.
- Show nearest Utility Pole and identify it by the affixed number.
- Draw a rough sketch of the proposed location and indicate sidewalk and driveway width and location where applicable.

Part III: Signature of Understanding

If, these permit conditions, including final restoration are not completed within the required length of time the undersigned must reapply for all applicable permits and pay all associated fees.

Any person, company, or business entity found not in compliance with this permit shall be subject to immediate revocation of permit privileges for the job being performed and suspension of all future work privileges until the job is brought into compliance. A stop-work order can be issued and recovery of the cost of materials, labor and inspection fees at prevailing rates can be charged to the undersigned to bring the job into compliance including forfeiture of any permit fee and/or deposit. In addition, for violation of the City of Schenectady Code section § 151, the undersigned will be guilty of a misdemeanor punishable by a fine not to exceed \$1,000 and/or 15 days in jail.

I, the undersigned, understand that the permit which may be issued pursuant to this application is done on the basis that all of the representations made on this permit application are true and accurate.

I understand that if any of the information given on this permit form is found to be untrue or inaccurate, or if the work initiated pursuant to a permit granted based on the representations made on this application, then the permit may be revoked without notice to myself, the contractor, or any other party.

I have read and understand all the provisions of the permit and shall comply with said requirements.

Applicant's Signature

Date

Applicant's Name (Please Print)

STREETS REQUIRING TINTED CONCRETE SIDEWALKS

Legend

-  Tinted Concrete Required
-  Street

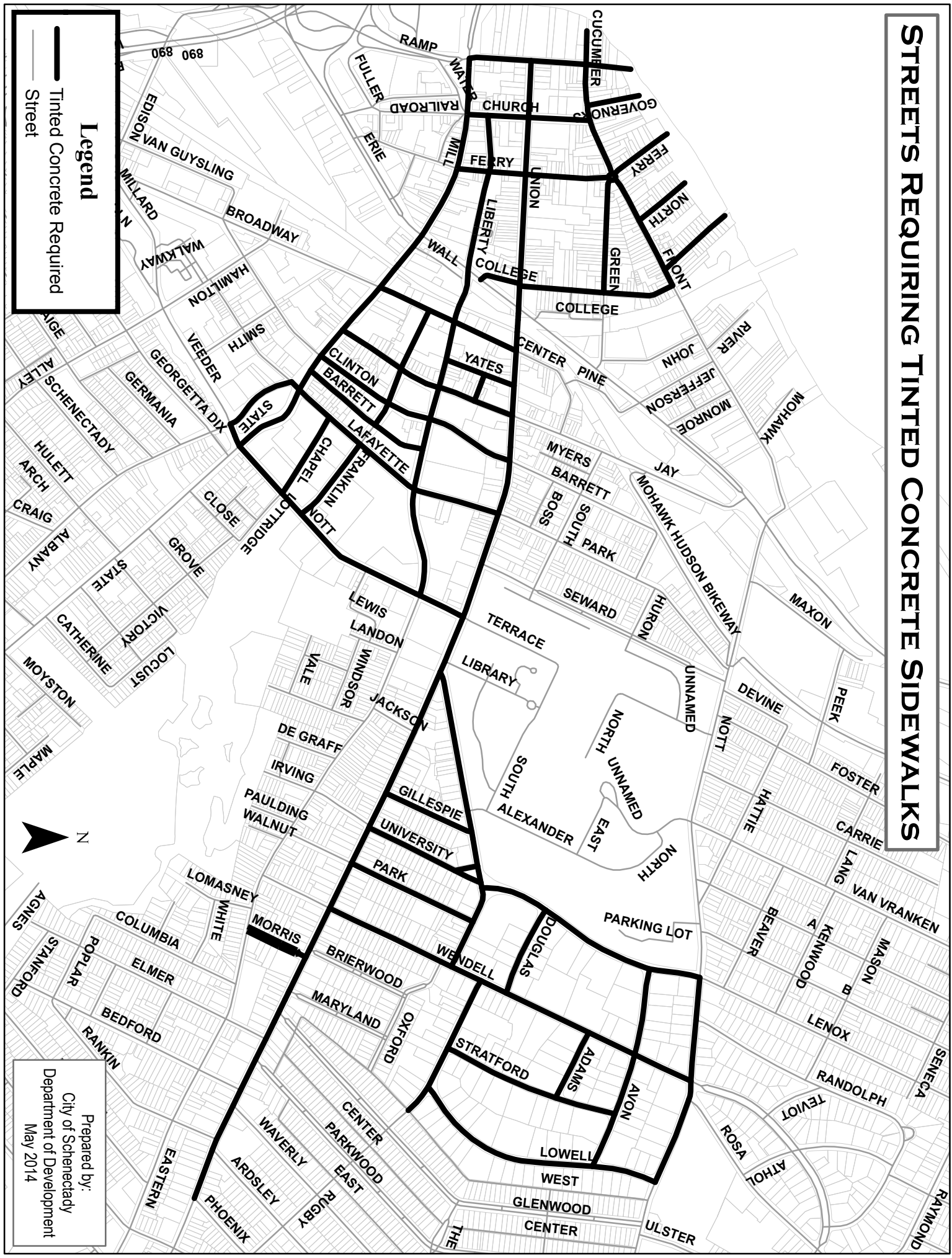

Prepared by:
 City of Schenectady
 Department of Development
 May 2014

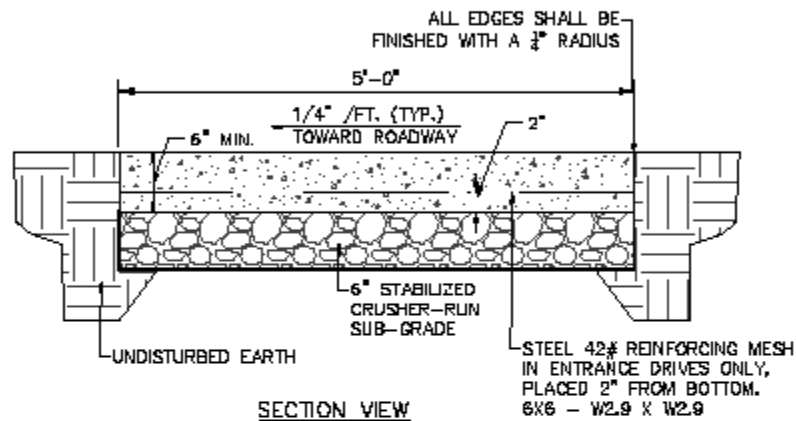

NOTES:

1. THE CONCRETE USED SHALL BE 4000 PSI PORTLAND CEMENT, AIR-ENTRAINED, CLASS "D" CONCRETE WITH AN AIR CONTENT OF 5% MIN., TO 7% MAX., AND A SLUMP OF TWO INCHES, MIN., TO THREE INCHES MAX.,
2. ALL NEW CONCRETE SIDEWALKS SHALL BE TRANSVERSELY SCORED TO ONE (1) INCH DEPTHS, 5' INTERVALS. FULL-DEPTH CONSTRUCTION JOINTS SHALL BE PROVIDED AT ALL DRIVEWAY CROSSINGS OR AT 20' INTERVALS, MAX.
3. ALL CURBING SHALL BE RESET OR REPLACED IN KIND AS REQUIRED, CONSISTENT IN EVERY RESPECT WITH CITY SPECIFICATION.
4. A PROTECTIVE SEALER SHALL BE APPLIED OVER THE ENTIRE SIDEWALK TO PRODUCE A DURABLE WEARING SURFACE.

 <p>CITY OF SCHENECTADY SCHENECTADY COUNTY, NEW YORK</p>	<p>MAYOR: GARY MCCARTHY</p> <p>COMMISSIONER OF GENERAL SERVICES: CARL OLSEN</p> <p>CITY ENGINEER: CHRISTOPHER WALLER, P.E.</p> <p>DEPARTMENT OF ENGINEERING 105 JAY ST. ROOM 305 CITY HALL SCHENECTADY, NY 12305-1926</p>	<p>PROJECT NO.: SIDEWALK SPECIFICATIONS</p> <p>DESIGNED BY: PBK</p> <p>DRAWN BY: PBK</p> <p>REVIEWED BY: CRW</p> <p>APPROVED BY: CRW</p> <p>DATE: 4/29/2013</p>	<p>SHEET TITLE: SIDEWALK DETAILS</p> <p>SCALE: NOT TO SCALE</p>	<p>LOGATOR:</p> <p>DRAWING NUMBER: G-001.1</p> <p>SHEET NUMBER: 1 of 4</p>
---	---	---	---	--

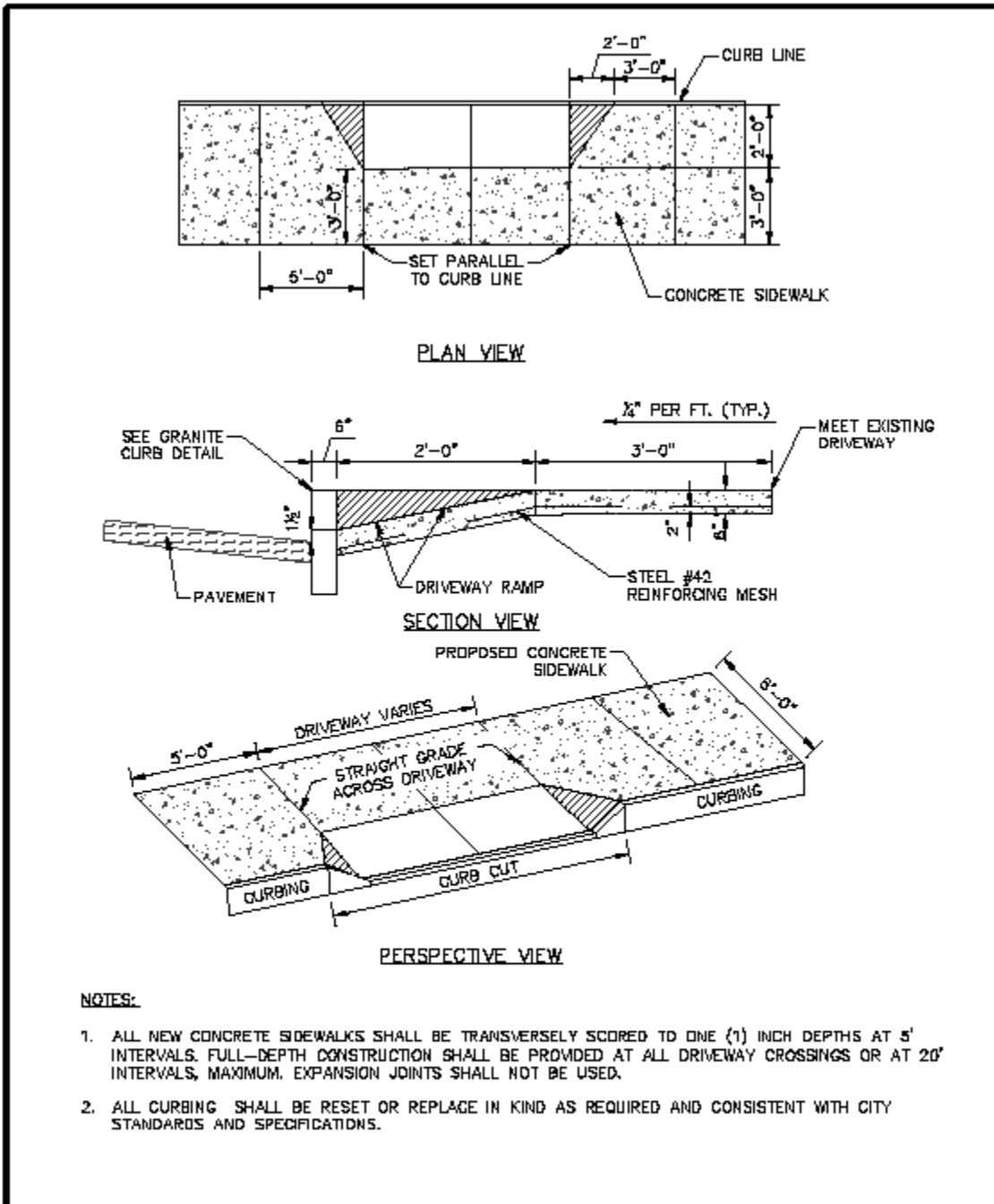

 CITY OF SCHENECTADY SCHENECTADY COUNTY, NEW YORK	NAME: GARY BOGARTY COMMISSIONER OF GENERAL SERVICES CARL OLSON	PROJECT NO.: DESIGNED BY: DRAWN BY: REVIEWED BY: APPROVED BY: DATE:	SIDEWALK SPECIFICATIONS PER PER DRW DRW 4/29/2013	SHEET TITLE: SIDEWALK NO BUFFER STRIP DETAILS SCALE: NOT TO SCALE	LOCATION: DRAWING NUMBER: G-001.2 SHEET NUMBER: 2 OF 4
---	---	--	--	---	--

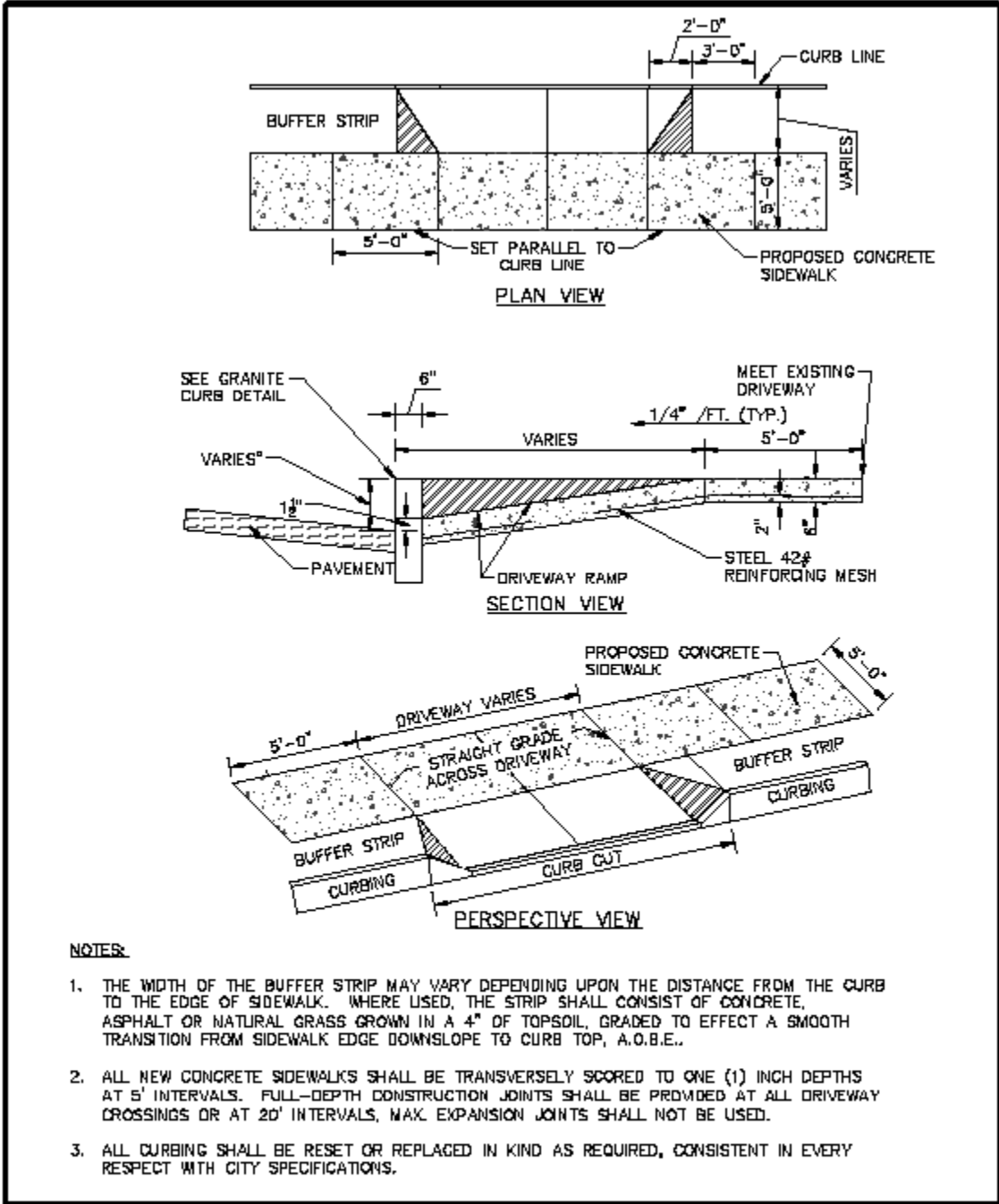

NOTES:

1. THE WIDTH OF THE BUFFER STRIP MAY VARY DEPENDING UPON THE DISTANCE FROM THE CURB TO THE EDGE OF SIDEWALK. WHERE USED, THE STRIP SHALL CONSIST OF CONCRETE, ASPHALT OR NATURAL GRASS GROWN IN A 4" OF TOPSOIL, GRADED TO EFFECT A SMOOTH TRANSITION FROM SIDEWALK EDGE DOWNSLOPE TO CURB TOP, A.O.B.E..
2. ALL NEW CONCRETE SIDEWALKS SHALL BE TRANSVERSELY SCORED TO ONE (1) INCH DEPTHS AT 5' INTERVALS. FULL-DEPTH CONSTRUCTION JOINTS SHALL BE PROVIDED AT ALL DRIVEWAY CROSSINGS OR AT 20' INTERVALS, MAX. EXPANSION JOINTS SHALL NOT BE USED.
3. ALL CURBING SHALL BE RESET OR REPLACED IN KIND AS REQUIRED, CONSISTENT IN EVERY RESPECT WITH CITY SPECIFICATIONS.

 CITY OF SCHENECTADY SCHENECTADY COUNTY, NEW YORK	SAUCE GARY WICKERTY COMMISSIONER OF GENERAL SERVICES CARE ORDER CITY ENGINEER CHRISTOPHER WALLER, P.E. DEPARTMENT OF ENGINEERING 185 JAY ST. ROOM 205 CITY HALL SCHENECTADY, NY 12305-1658	PROJECT NO:1	SIDEWALK SPECIFICATIONS	SHEET TITLE	LOCATION:
		DESIGNED BY: FBK		SIDEWALK BUFFER STRIP DETAILS	DRAWING NUMBER: G-D01.3
		DRAWN BY: FBK		DESIGNER	SHEET NUMBER: 3 of 4
		REVIEWED BY: CRW		NOT TO SCALE	
		APPROVED BY: CRW			
		DATE: 4/28/2013			

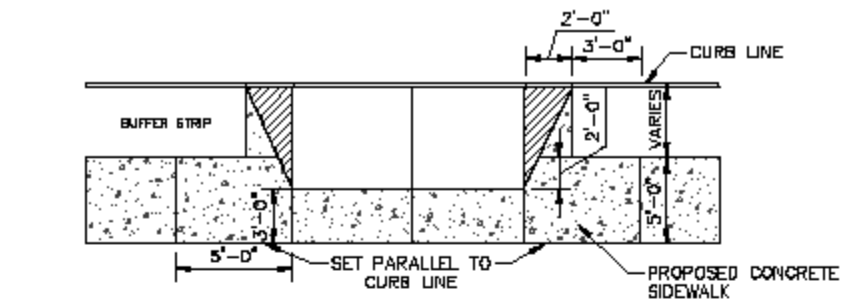

PLAN VIEW

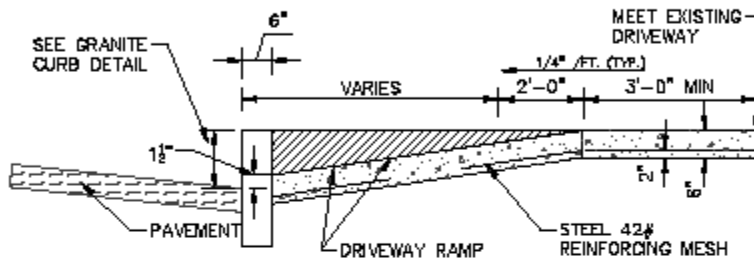

SECTION VIEW

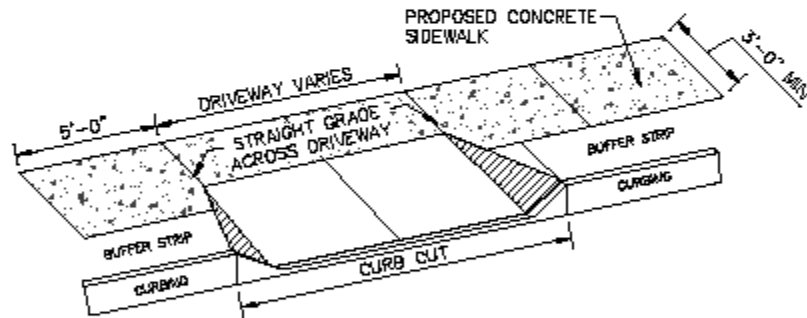

PERSPECTIVE VIEW

NOTES:

1. THE WIDTH OF THE BUFFER STRIP MAY VARY DEPENDING UPON THE DISTANCE FROM THE CURB TO THE FRONT EDGE OF SIDEWALK. WHERE USED, THE STRIP SHALL CONSIST OF CONCRETE, ASPHALT OR NATURAL GRASS GROWN IN A 4" OF TOPSOIL, GRADED TO EFFECT A SMOOTH TRANSITION FROM SIDEWALK EDGE DOWNSLOPE TO CURB TOP, A.D.B.E.
2. ALL NEW CONCRETE SIDEWALKS SHALL BE TRANSVERSELY SCORED TO ONE (1) INCH DEPTHS AT 5' INTERVALS. FULL-DEPTH CONSTRUCTION JOINTS SHALL BE PROVIDED AT ALL DRIVEWAY CROSSINGS OR AT 20' INTERVALS, MAX. EXPANSION JOINTS SHALL NOT BE USED.
3. ALL CURBING SHALL BE RESET OR REPLACED IN KIND AS REQUIRED, CONSISTENT IN EVERY RESPECT WITH CITY SPECIFICATION.



CITY OF SCHENECTADY
SCHENECTADY COUNTY,
NEW YORK

SAYOR:
GARY MCCORMY
COMMISSIONER OF GENERAL SERVICES
CARL OLSER
CITY ENGINEER:
CHRISTOPHER WALKER, P.E.
DEPARTMENT OF ENGINEERING
165 JAY ST. ROOM 305 CITY HALL
SCHENECTADY, NY 12305-1658

PROJECT NO.	SIDEWALK SPECIFICATIONS	SHEET TITLE:
DESIGNED BY	PBK	SIDEWALK NARROW BUFFER STRIP DETAILS
DRAWN BY	PBK	
REVIEWED BY	CRW	SCALE:
APPROVED BY	CRW	NOT TO SCALE
DATE	4/29/2013	

LOCATION:
DRAWING NUMBER: G-001.4
SHEET NUMBER: 4 OF 4

TYPICAL CURB REVEAL

- NEW CONSTRUCTION 6" REVEAL
- EXISTING PAVEMENT VARIES (MATCH EXISTING REVEAL)

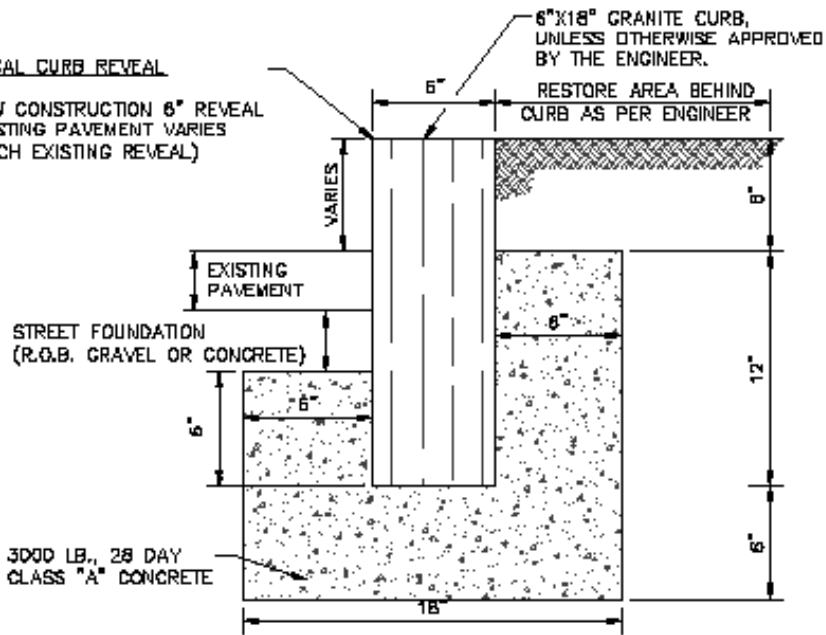

NOTES:

1. NEW CURBS SHALL BE SET TO PRODUCE A SMOOTH TRANSITION FROM EXISTING CURB TO EXISTING CURB A.O.B.E

 <p>CITY OF SENECADAY SENECADAY COUNTY, NEW YORK</p>	<p>MAJOR GARY BOONSHY</p> <p>COMMISSIONER OF GENERAL SERVICES CIVIL CLERK</p> <p>CITY ENGINEER CHRISTOPHER TULLA, P.E.</p> <p>DEPARTMENT OF ENGINEERING 100 JAY ST. ROOM 302 CITY HALL SENECADAY, NY 13256-1828</p>	PROJECT NO.	GRANITE CURB INSTALL	SHEET TITLE	GRANITE CURB INSTALLATION	LOCATION	
		DESIGNED BY	PBK	SCALE			NOT TO SCALE
		DRAWN BY	PBK		SHEET NUMBER	1 OF 1	
		REVIEWED BY	CRW				
		APPROVED BY	CRW				
DATE	4/25/2013						

ACORD **CERTIFICATE OF LIABILITY INSURANCE** **DATE (MM/DD/YYYY)**
 TM. **09 13 2004**

PRODUCER	THIS CERTIFICATE IS ISSUED AS A MATTER OF INFORMATION ONLY AND CONFERS NO RIGHTS UPON THE CERTIFICATE HOLDER. THIS CERTIFICATE DOES NOT AMEND, EXTEND OR ALTER THE COVERAGE AFFORDED BY THE POLICES BELOW.	
	INSURERS AFFORDING COVERAGE	NAIC #
INSURED JOHN & JANE DOE 000 ANY STREET ANY TOWN, ANY STATE 00000	INSURER A:	
	INSURER B:	
	INSURER C:	
	INSURER D:	
	INSURER E:	

COVERAGES

THE POLICES OF INSURANCE LISTED BELOW HAVE BEEN ISSUED TO THE INSURED NAMES ABOVE FOR THE POLY PERIOD INDICATED, NOTWITHSTANDING ANY REQUIREMENT, TERM OR CONDITION OF ANY CONTRACT OR OTHER DOCUMENT WITH RESPECT TO WHICH THIS CERTIFICATE MAY BE ISSUED OR MAY PERTAIN, THE INSURANCE AFFORDED BY THE POLICIES DESCRIBED HEREIN IS SUBJECT TO ALL THE TERMS, EXCLUSIONS, AND CONDITIONS OF SUCH POLICES. AGGREGATES LIMITS SHOWN MAY HAVE BEEN REDUCED BY PAID CLAIMS.

INSR. LTR	TYPE OF INSURANCE	POLICY NUMBER	POLICY EFFECTIVE DATE (MM/DD/YYYY)	POLICY EXPIRATION	LIMITS	
A	GENERAL LIABILITY <input type="checkbox"/> COMMERCIAL GENERAL LIABILITY <input type="checkbox"/> CLAIMS MADE <input type="checkbox"/> OCCUR <input type="checkbox"/> <input type="checkbox"/> GEN'L AGGREGATE LIMIT APPLIES PER: <input type="checkbox"/> POLICY <input type="checkbox"/> PRODUCT <input type="checkbox"/> LOC				EACH OCCURRENCE	\$ 1,000,000.00
					FIRE DAMAGE (Any one fire)	\$ -
					MED EXP. (any one person)	\$ -
					PERSONAL & ADV INJURY	\$ -
					GENERAL AGGRREGATE	\$ 2,000,000.00
					PRODUCTS-COMP/OP AGG	\$ -
A	AUTOMOBILE LIABILITY <input type="checkbox"/> ANY AUTO <input type="checkbox"/> ALL OWNED AUTOS <input type="checkbox"/> SCHEDULED AUTOS <input type="checkbox"/> HIRED AUTOS <input type="checkbox"/> NON-OWNED AUTOS <input type="checkbox"/>				COMBINED SINGLE LIMIT (Each accident)	\$ -
					BODILY INJURY (Per person)	\$ -
					BODILY INJURY (Per person)	\$ -
					PROPERTY DAMAGE (per accident)	\$ 500,000.00
	GARAGE LIABILITY <input type="checkbox"/> ANY AUTO <input type="checkbox"/>	SAMPLE			AUTO ONLY - EA ACCIDENT	\$ -
					OTHER THAN EA ACC	\$ -
					AUTO ONLY AGG	\$ -
	EXCESS/UMBRELLA LIABILITY <input type="checkbox"/> OCCUR <input type="checkbox"/> CLAIMS MADE <input type="checkbox"/> DEDUCTIBLE <input type="checkbox"/> RETENTION \$				EACH OCCURRENCE	\$ 250,000.00
					AGGREGATE	\$ -
						\$ -
						\$ -
	WORKERS COMPENSATION AND EMPLOYERS' LIABILITY				<input type="checkbox"/> WO STATU- <input type="checkbox"/> OTHER	
					TORY LIMITS	
					E.L. EACH ACCIDENT	
					E.L. DISEASE - EA EMPLOYEE	
					E.L. DISEASE - POLICY LIMIT	

DESCRIPTION OF OPERATIONS/LOCATIONS/VEHICLES/EXCLUSIONS ADDED BY ENDORSEMENT/ SPECIAL PROVISIONS
 THE CITY OF SCHENECTADY IS ADDITIONALLY INSURED

CERTIFICATE HOLDER	CANCELLATION
City of Schenectady 105 Jay St, Room #205 NY 12305 Schenectady	SHOULD ANY OF THE ABOVE DESCRIBED POLICES BE CANCELLED BEFORE THE EXPIRATION DATE THEREOF, THE ISSUING COMPANY WILL ENDEAVOR TO MAIL 30 DAYS WRITTEN NOTICE TO THE CERTIFICATE HOLDER NAMED TO THE LEFT, BUT FAILURE TO DO SO SHALL IMPOSE NO OBLIGATION OR LIABILITY OF ANY KIND UPON THE INSURER, IT'S AGENTS OR REPRESENTATIVE. AUTHORIZED REPRESENTATIVE